

FOR "SECRET"

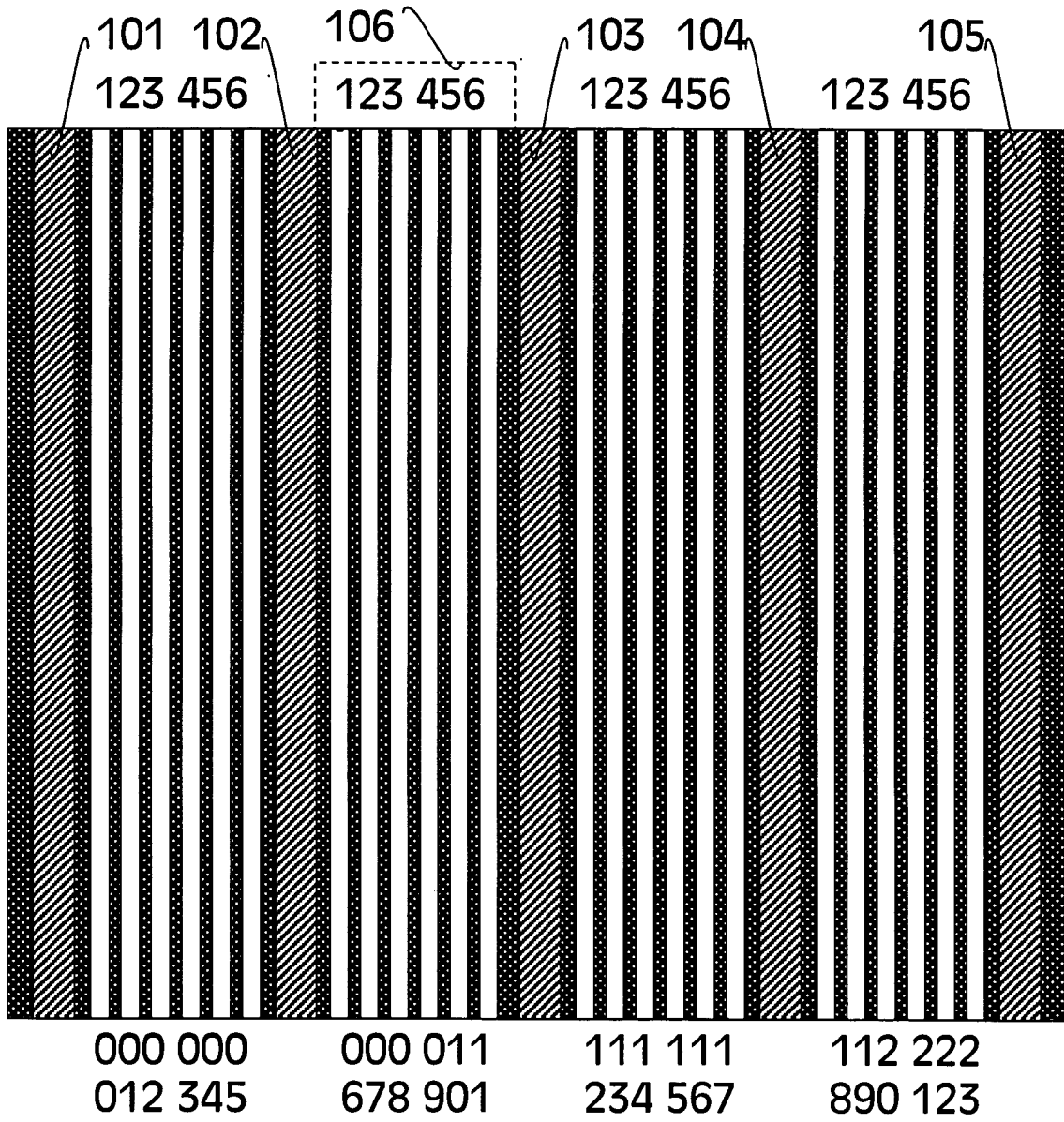

FIG. 1

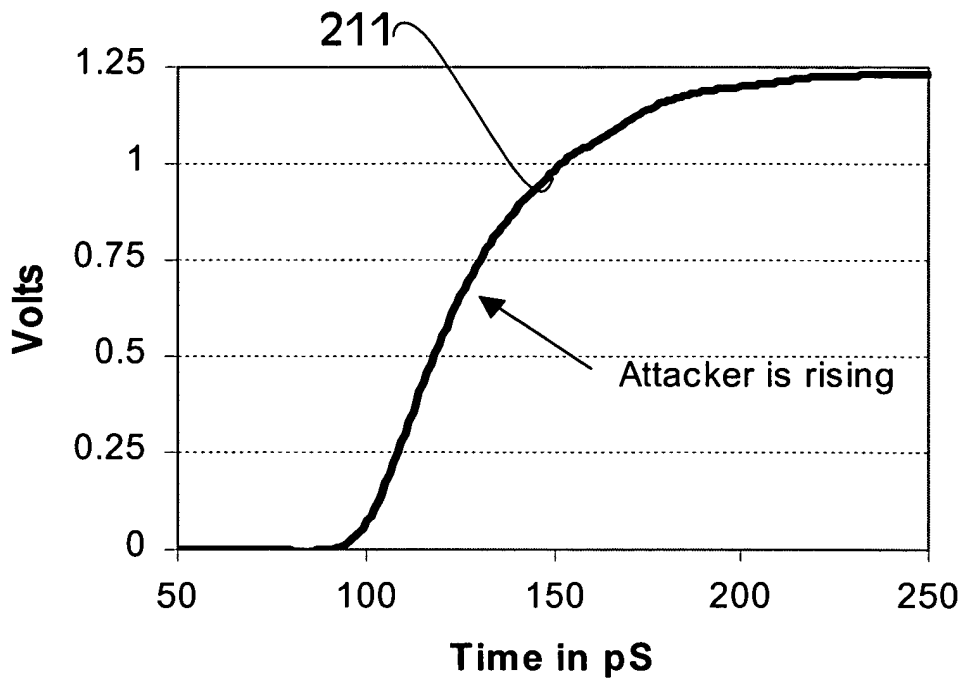

FIG. 2a

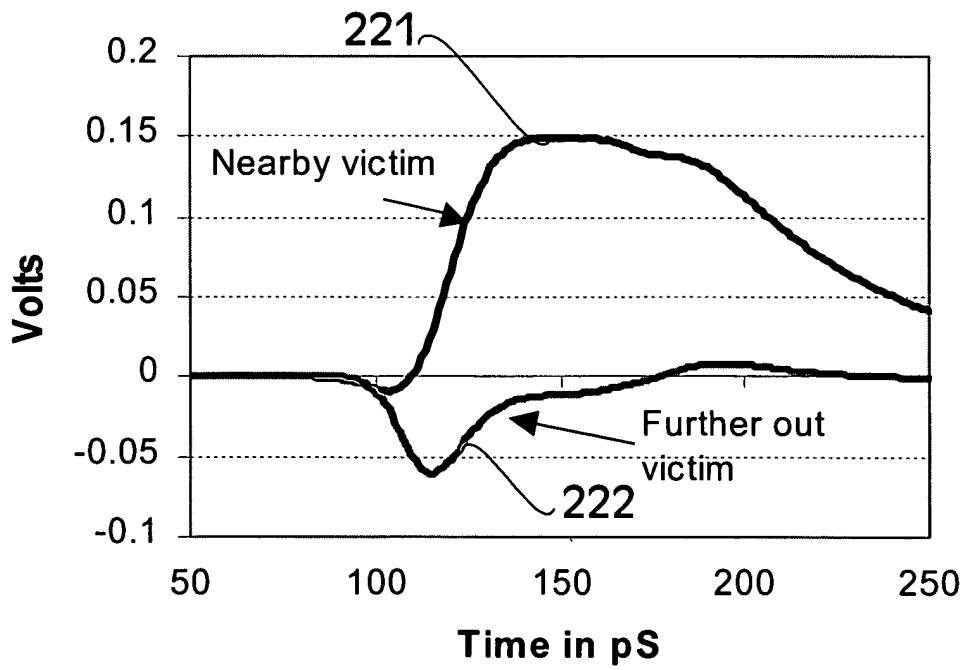

FIG. 2b

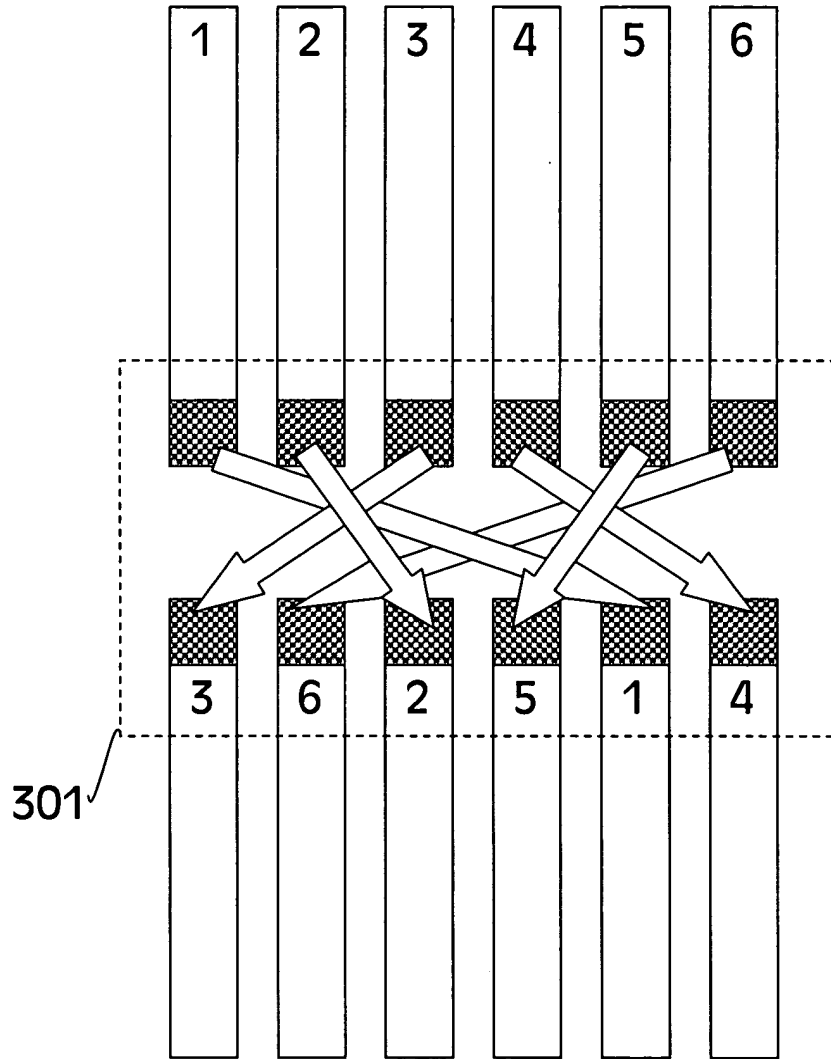

FIG. 3

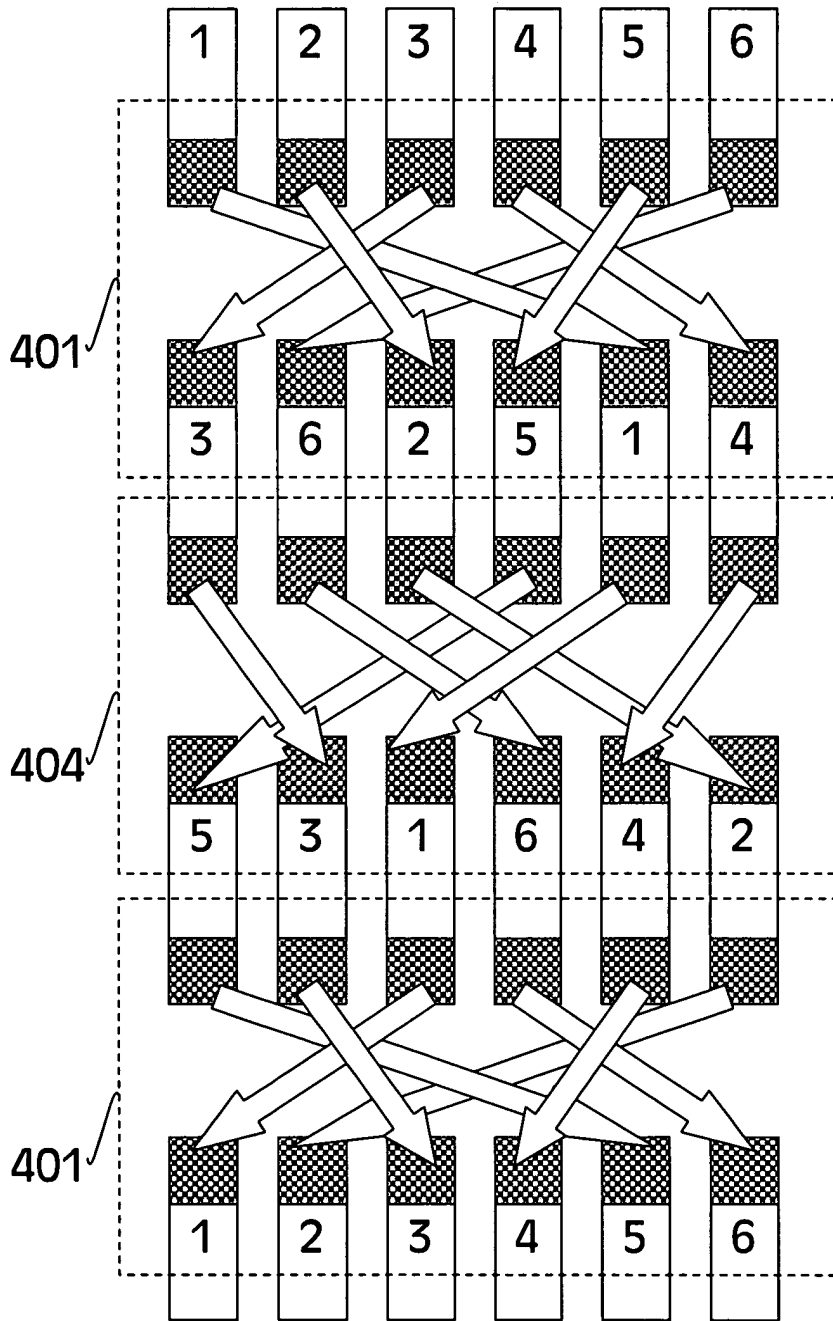

FIG. 4a

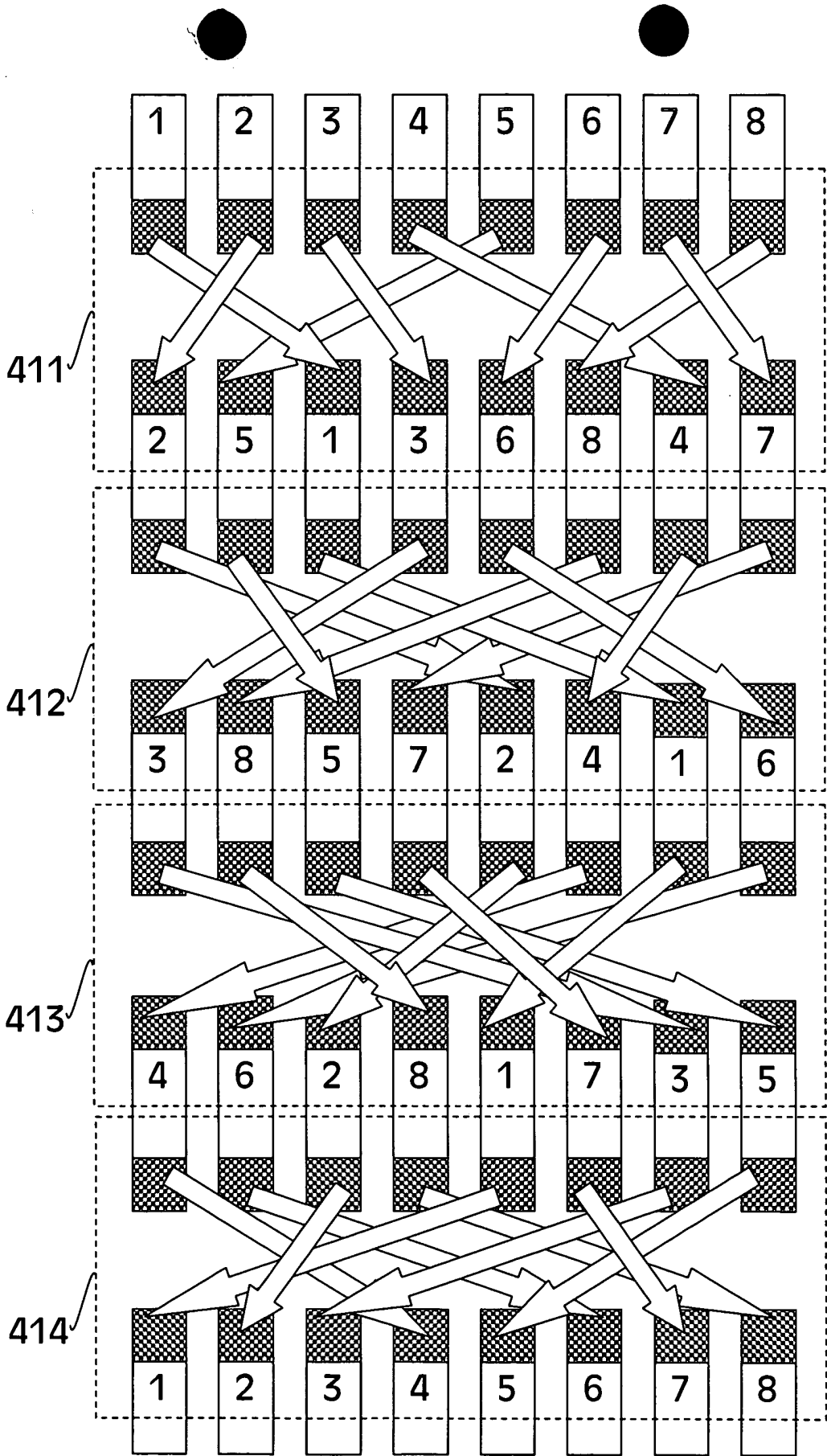
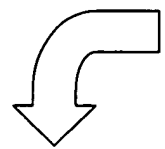

FIG. 4b

FIG. 5

	1	2	3	4	5	6
1	1	1	0	0	0	0
2	1	1	1	0	0	0
3	0	1	1	1	0	0
4	0	0	1	1	1	0
5	0	0	0	1	1	1
6	0	0	0	0	1	1

506



3	1	5	2	6	4
---	---	---	---	---	---

501

	1	2	3	4	5	6
1	1	1	1	0	1	0
2	1	1	1	0	1	1
3	1	1	1	1	0	0
4	0	0	1	1	1	1
5	1	1	0	1	1	1
6	0	1	0	1	1	1

507

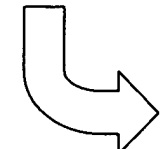

2	4	1	6	3	5
---	---	---	---	---	---

504

	1	2	3	4	5	6
1	1	1	1	1	1	1
2	1	1	1	1	1	1
3	1	1	1	1	1	1
4	1	1	1	1	1	1
5	1	1	1	1	1	1
6	1	1	1	1	1	1

508

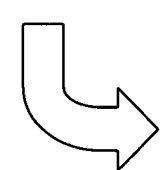

"TOP SECRET" REF ID: A66455

FIG. 6a

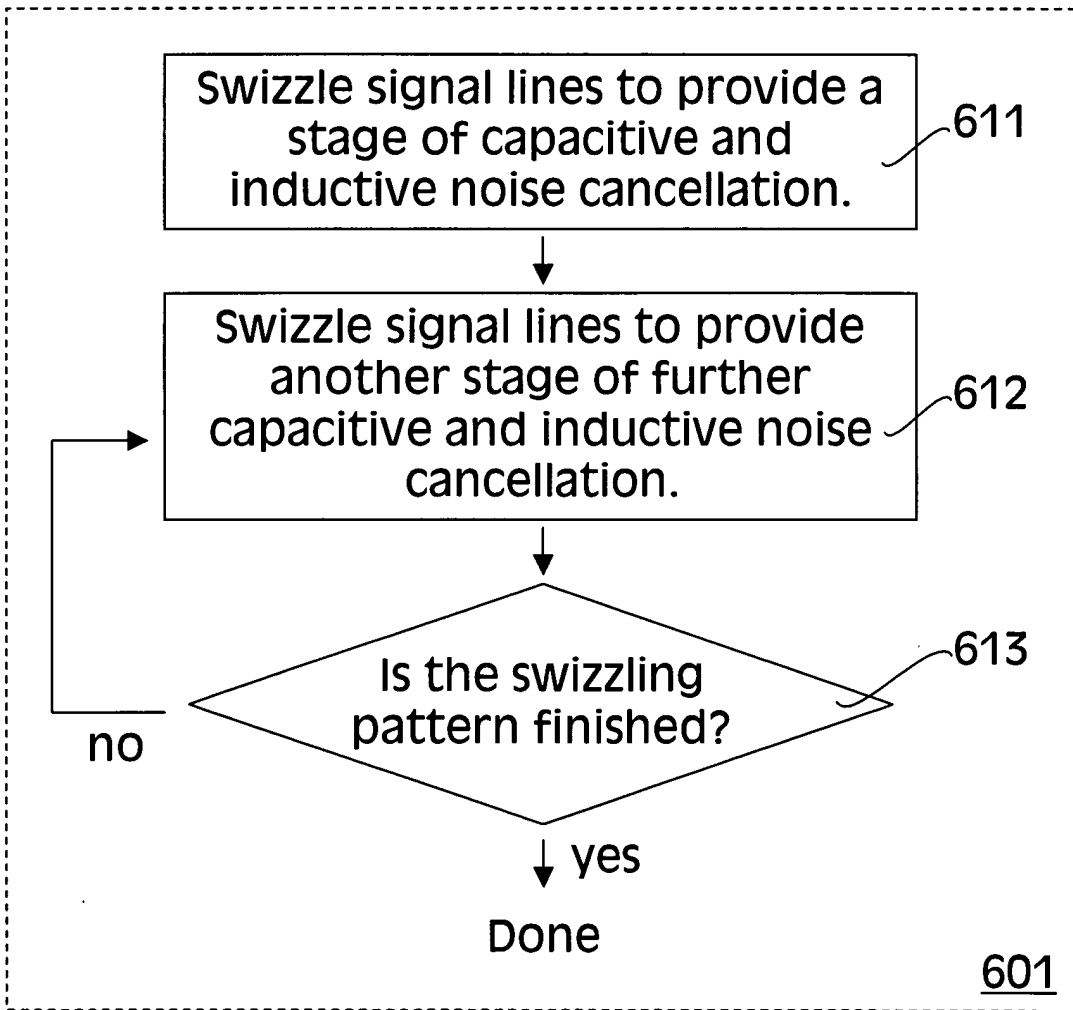
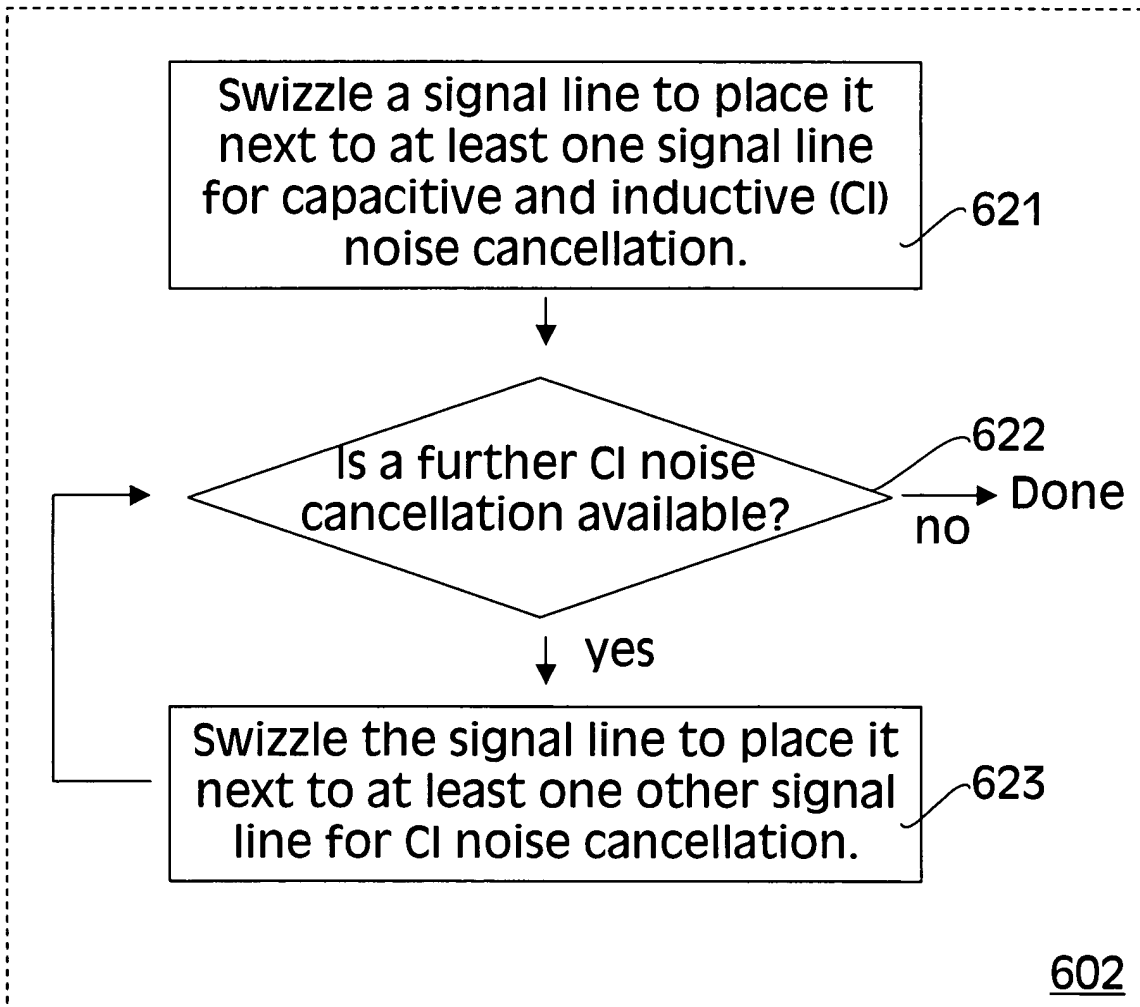

FIG. 6a

FIG. 6b



FOR SET "SESCOOT"



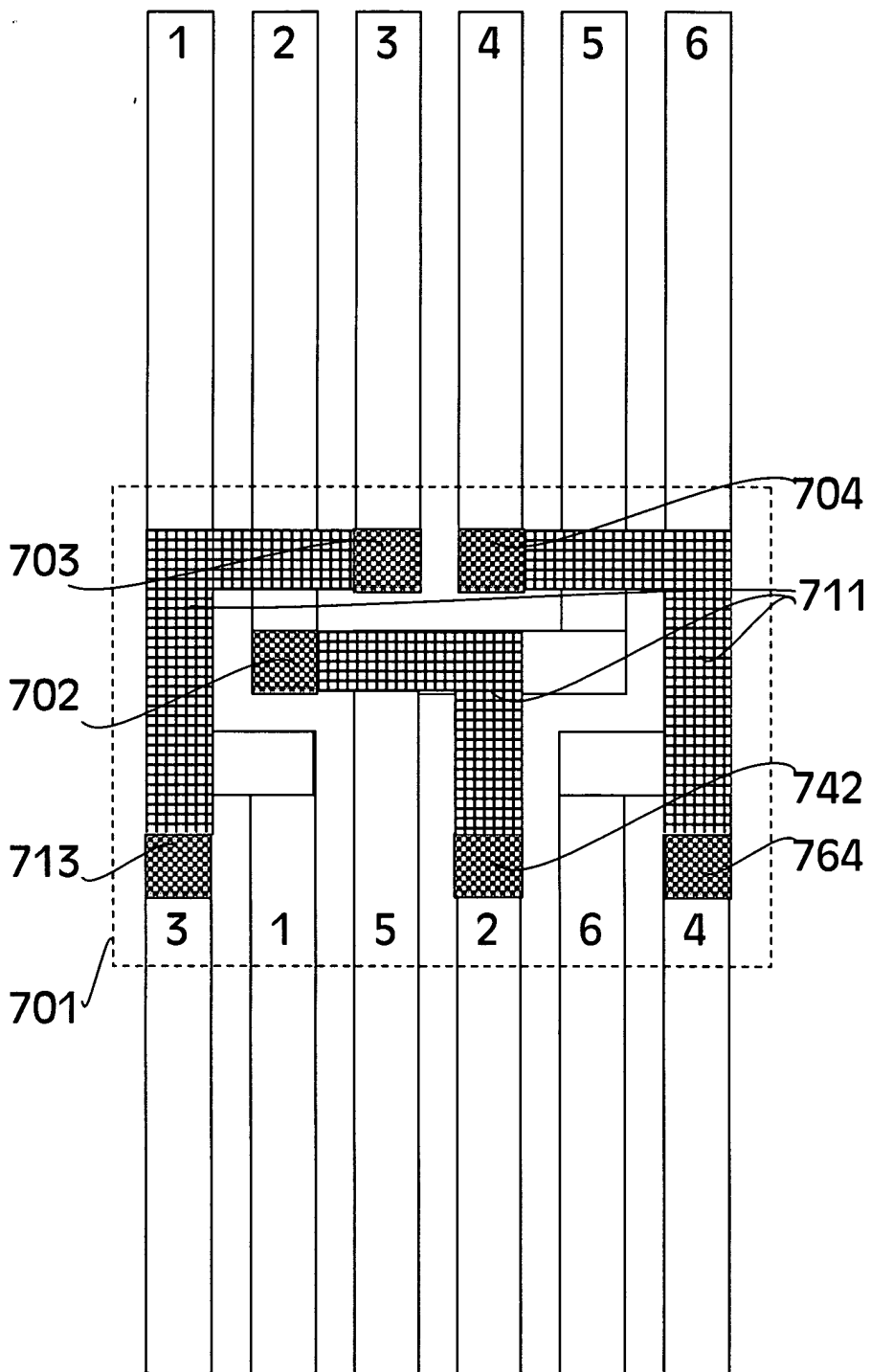
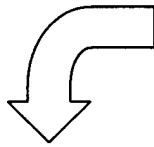

FIG. 7

FIG. 8a

	1	2	3	4	5	6
1	1	1	0	0	0	0
2	1	1	1	0	0	0
3	0	1	1	1	0	0
4	0	0	1	1	1	0
5	0	0	0	1	1	1
6	0	0	0	0	1	1

806



4	1	5	2	6	3
---	---	---	---	---	---

804

	1	2	3	4	5	6
1	1	1	0	1	1	0
2	1	1	1	0	1	1
3	0	1	1	1	0	1
4	1	0	1	1	1	0
5	1	1	0	1	1	1
6	0	1	1	0	1	1

807

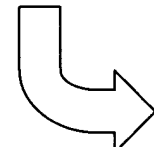

2	4	6	1	3	5
---	---	---	---	---	---

814

	1	2	3	4	5	6
1	1	1	1	1	1	1
2	1	1	1	1	1	1
3	1	1	1	1	1	1
4	1	1	1	1	1	1
5	1	1	1	1	1	1
6	1	1	1	1	1	1

808

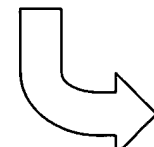

"SECRET" REF ID: A66047

FIG. 8b

	1	2	3	4	5	6
1	x	0	x	x	x	x
2	0	x	0	x	x	x
3	x	0	x	0	x	x
4	x	x	0	x	0	x
5	x	x	x	0	x	0
6	x	x	x	x	0	x

816

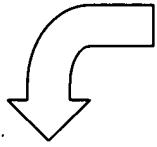

4	1	5	2	6	3
---	---	---	---	---	---

804

	1	2	3	4	5	6
1	x	0	x	1	1	x
2	0	x	0	x	1	1
3	x	0	x	0	x	1
4	1	x	0	x	0	x
5	1	1	x	0	x	0
6	x	1	1	x	0	x

817

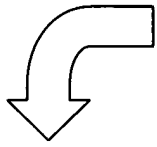

2	4	6	1	3	5
---	---	---	---	---	---

814

	1	2	3	4	5	6
1	x	0	2	1	1	2
2	0	x	0	2	1	1
3	2	0	x	0	2	1
4	1	2	0	x	0	2
5	1	1	2	0	x	0
6	2	1	1	2	0	x

818

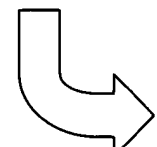

"PAGES" SEQUENCE

FIG. 8c

FIGURE 8c

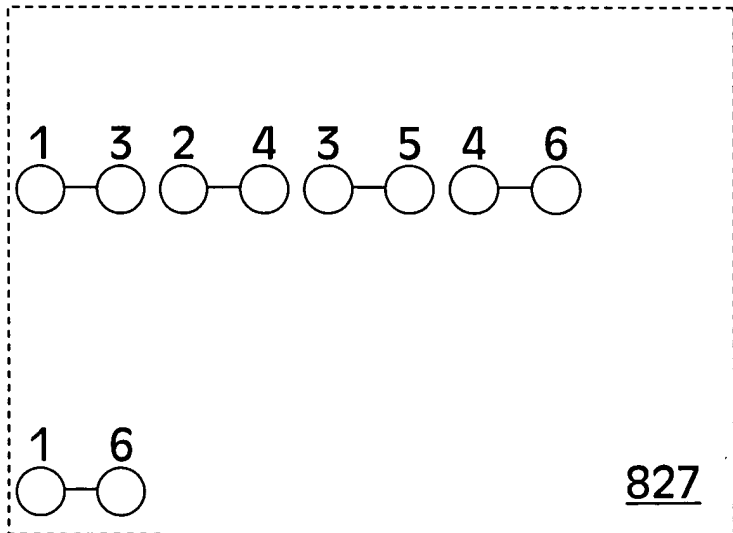
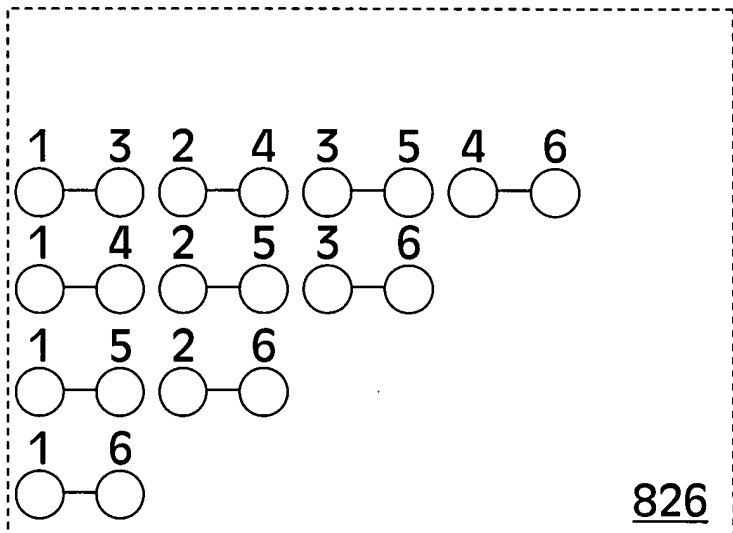
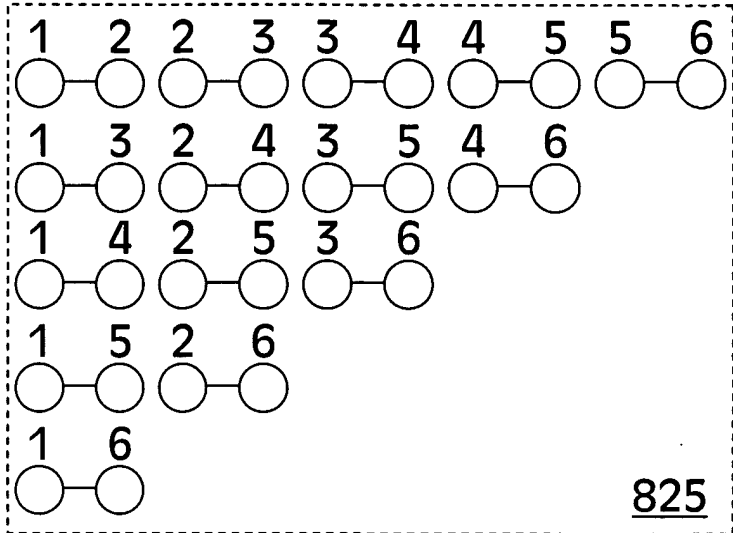
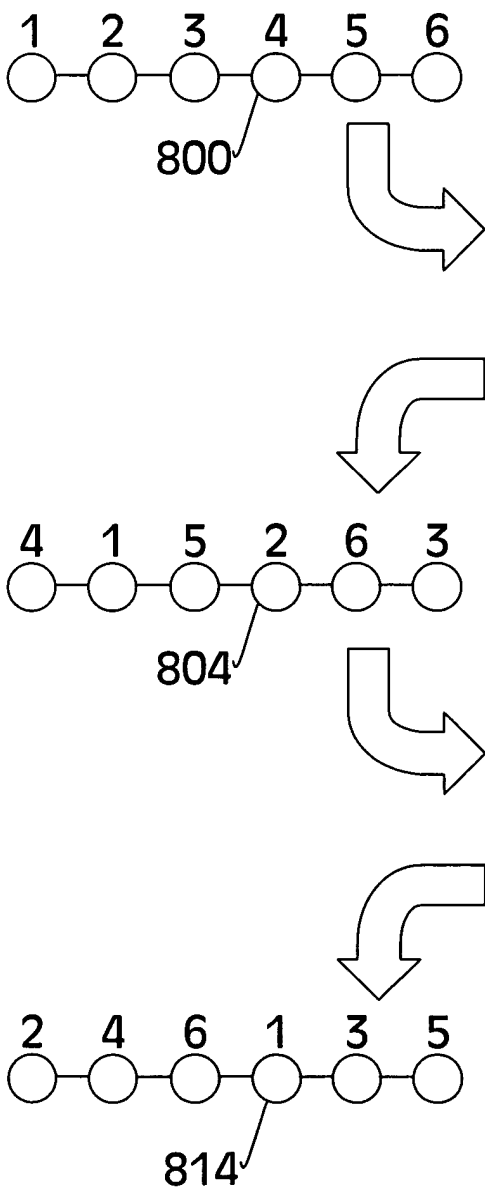

FIG. 9a

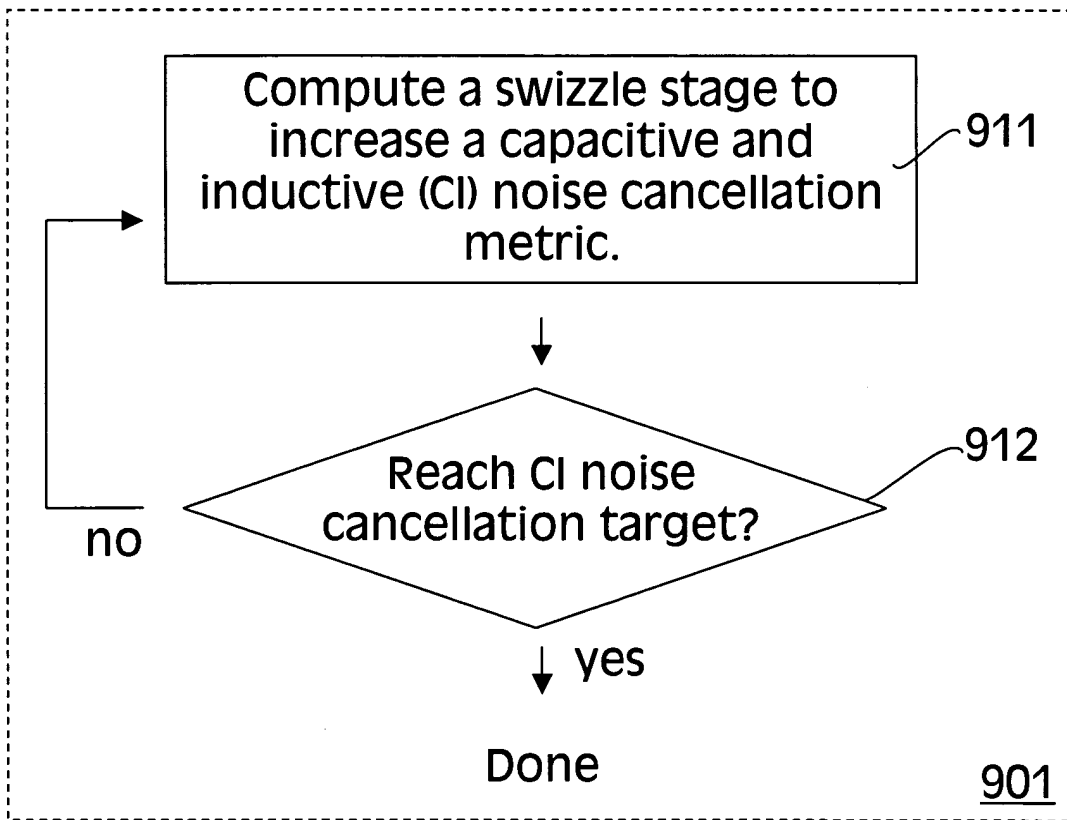

FIG. 9a

FIG. 9b

FIG. 9b

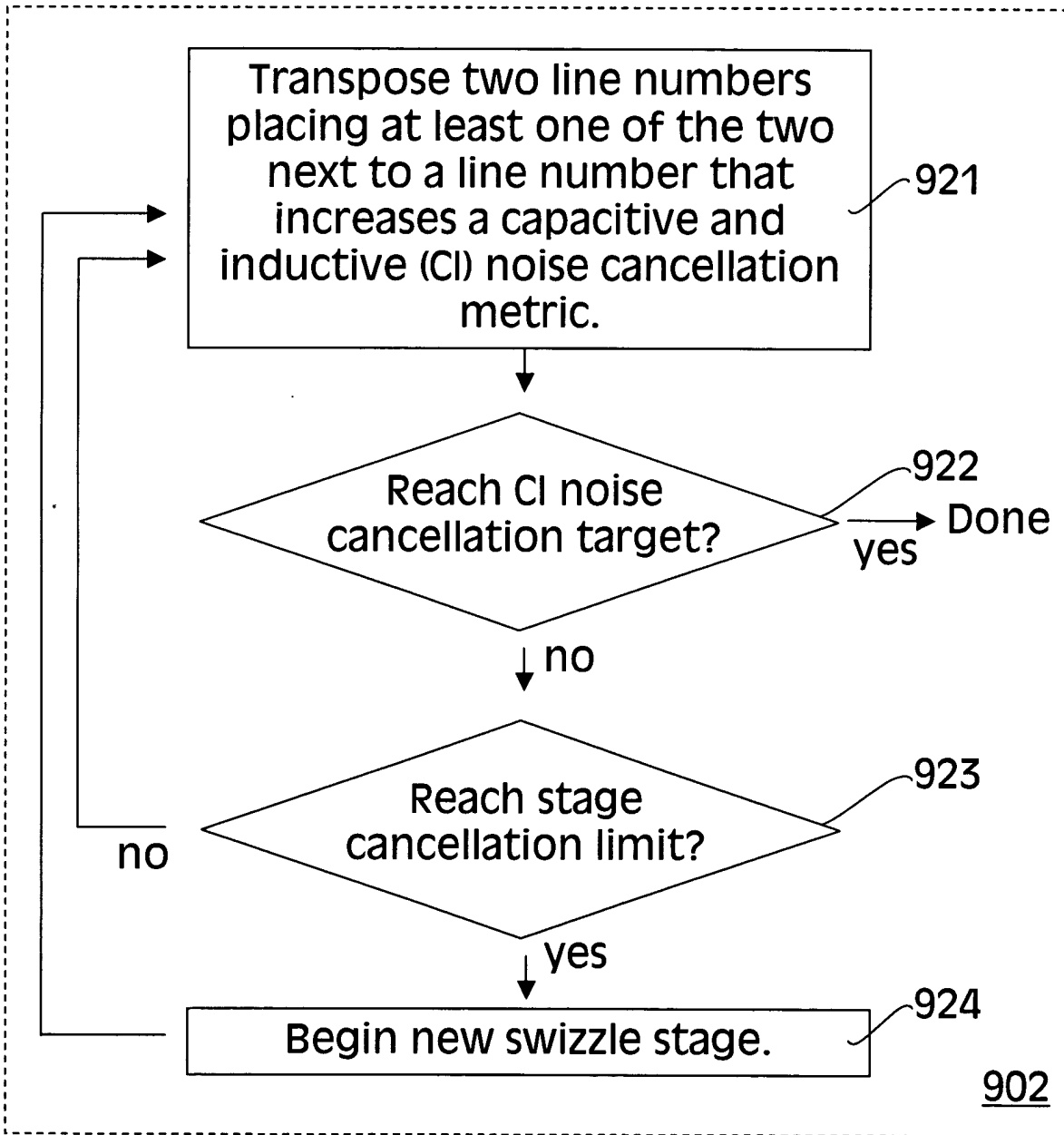
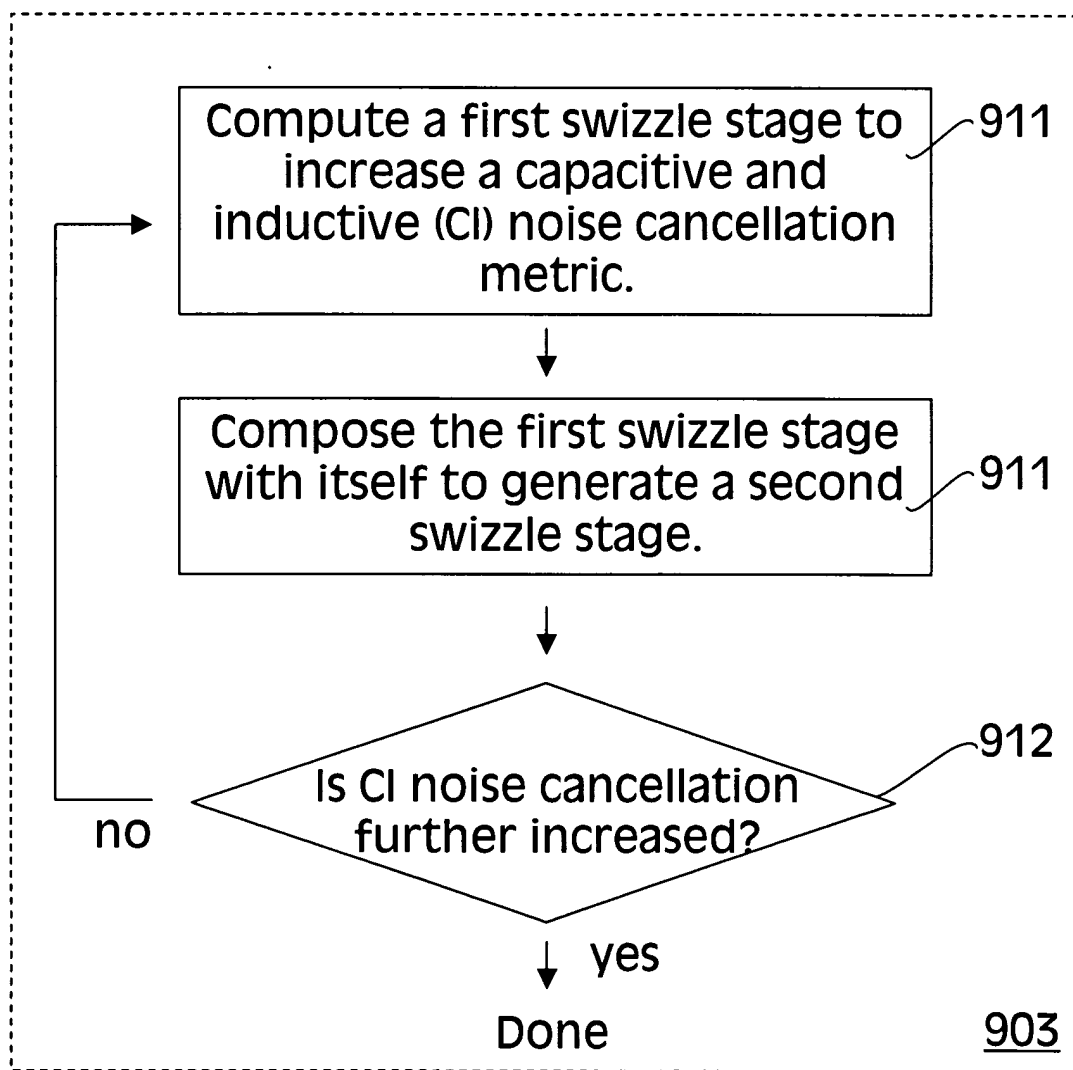

FIG. 9c

FIG. 9c



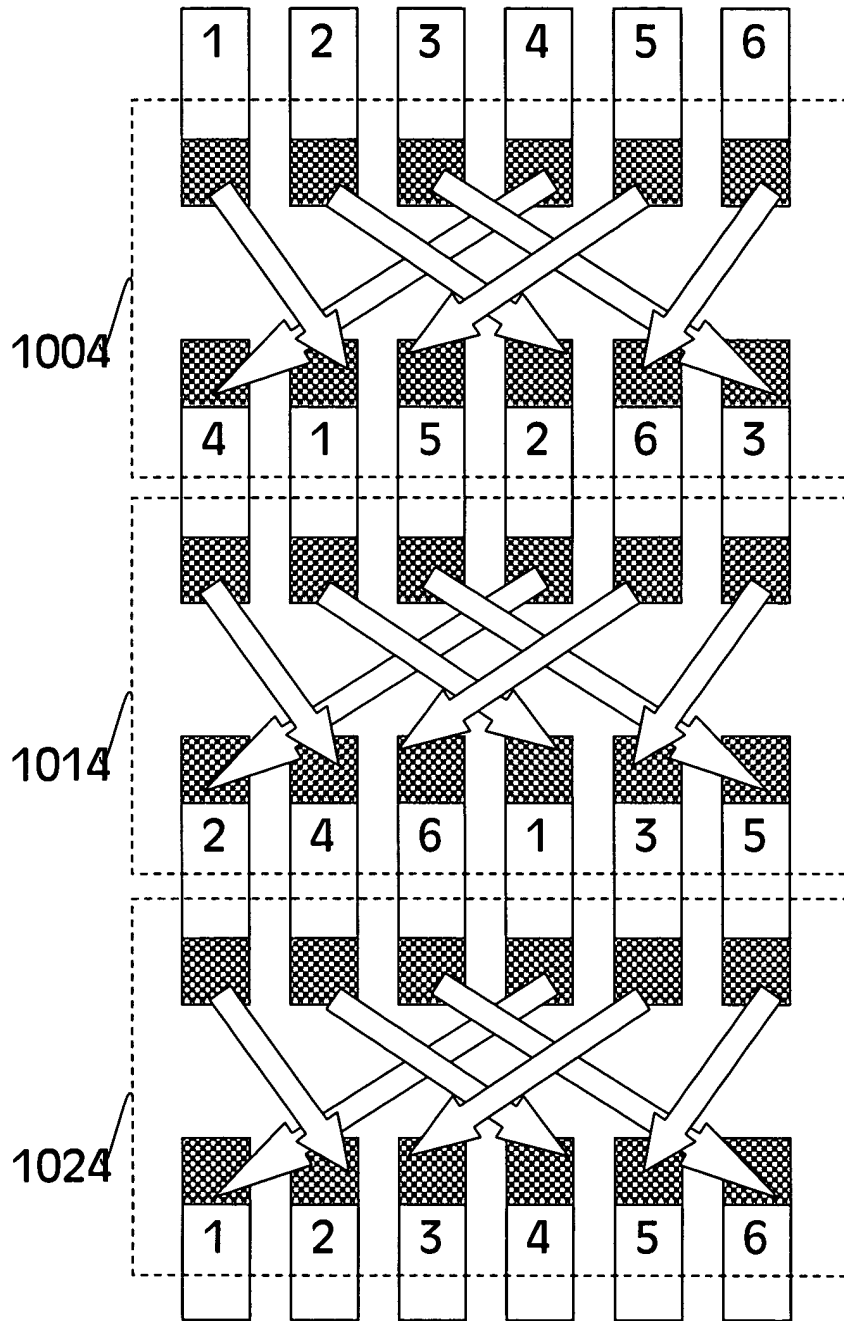

FIG. 10a



FIG. 10b

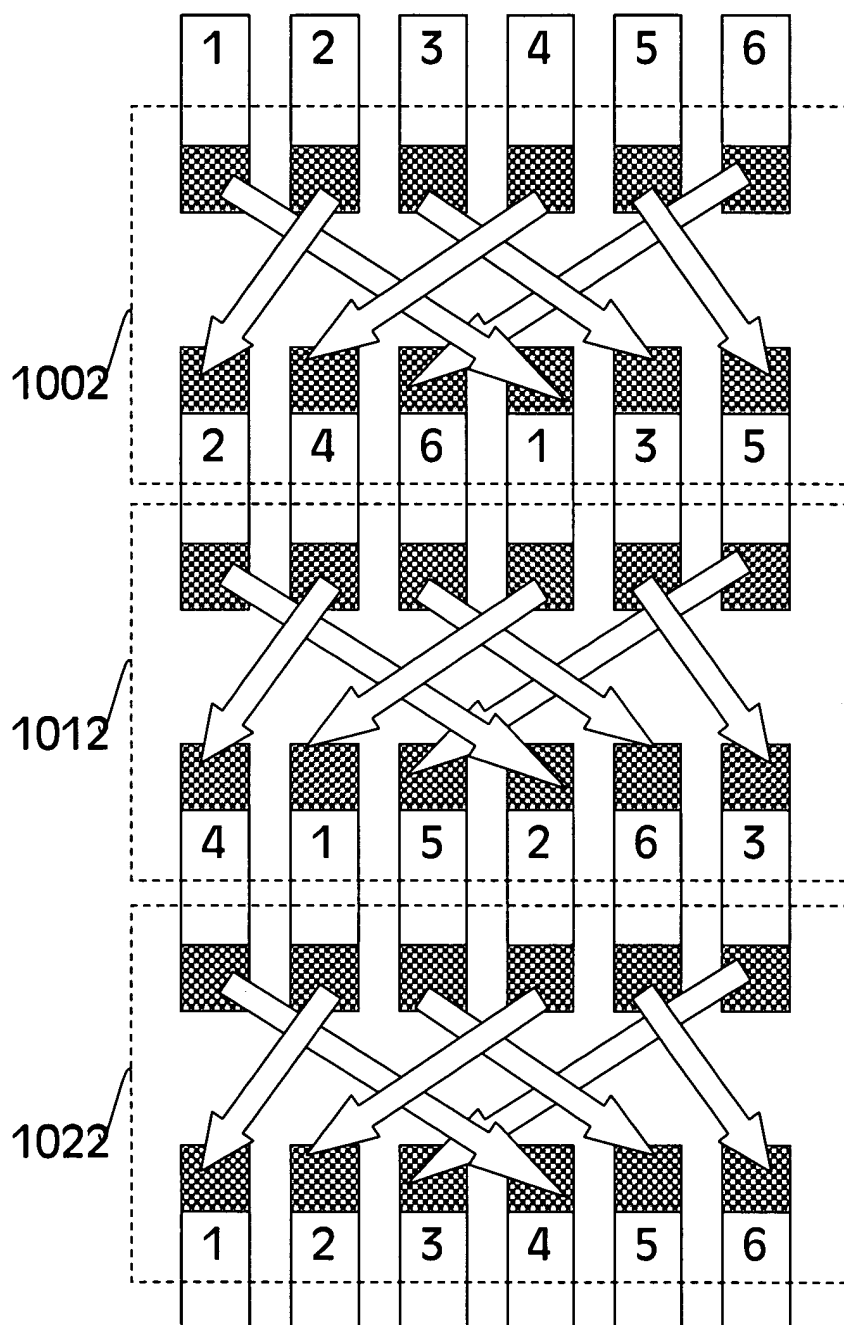

FIG. 10b

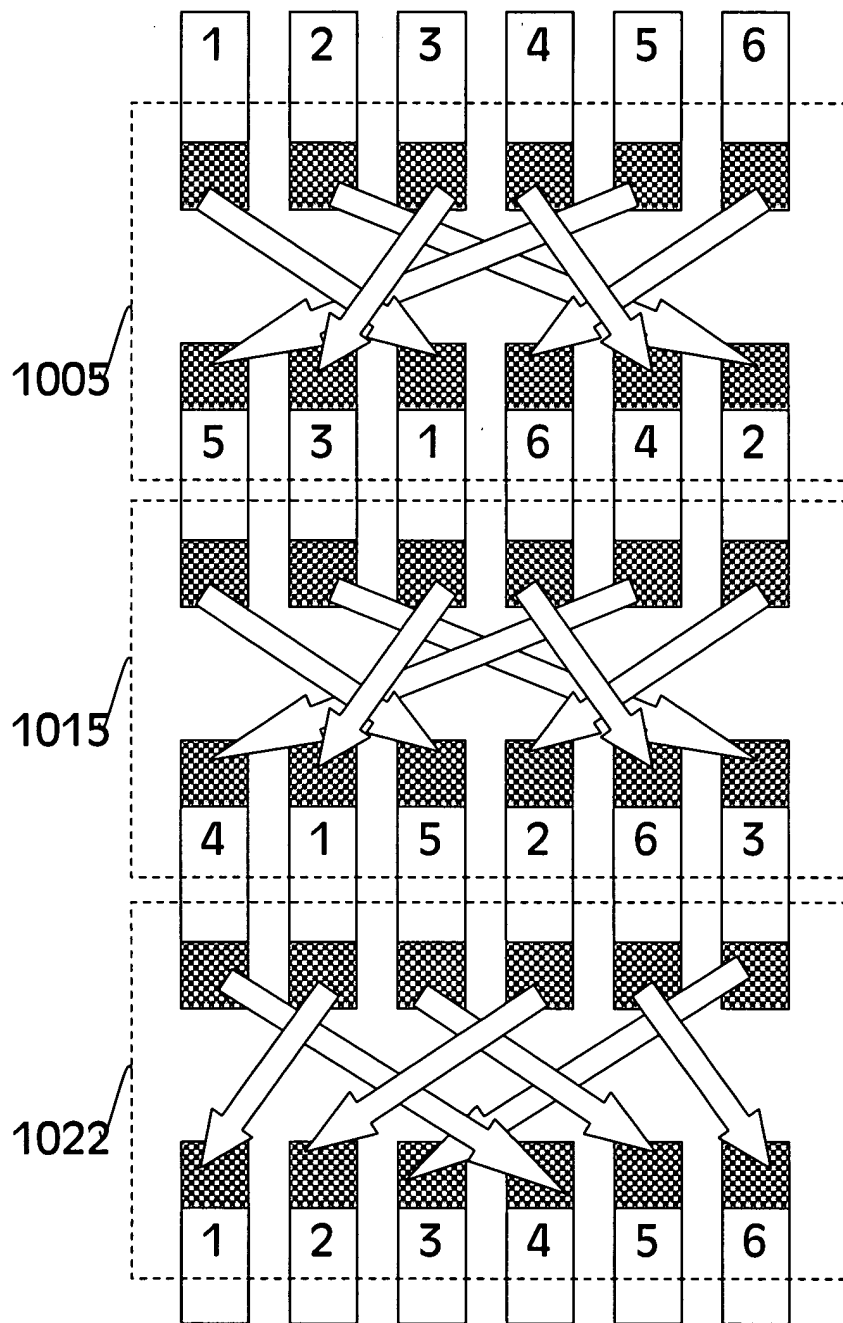

FIG. 10c

FIG. 10d

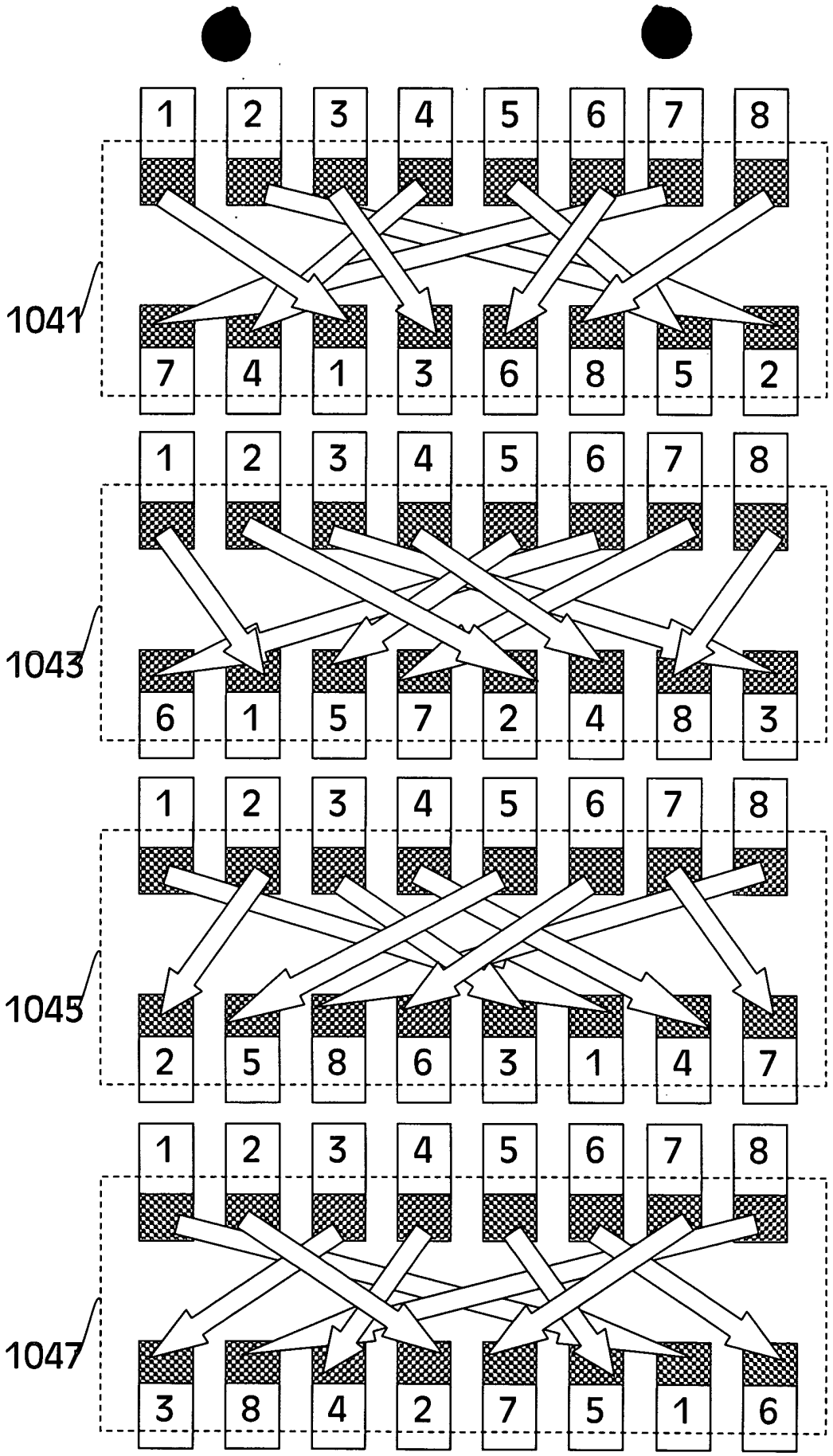

FIG. 10d

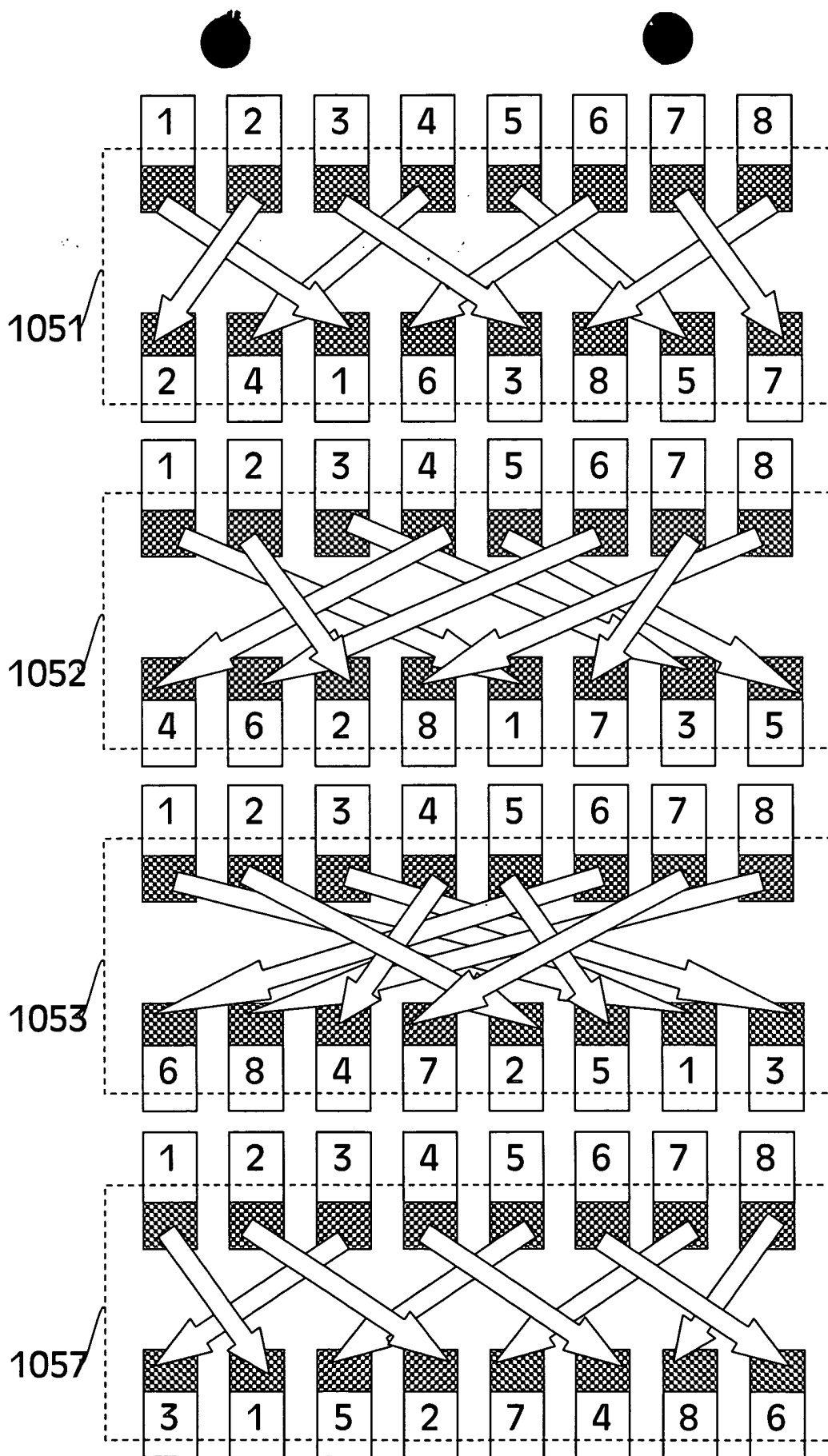

FIG. 10e

FIG. 11a

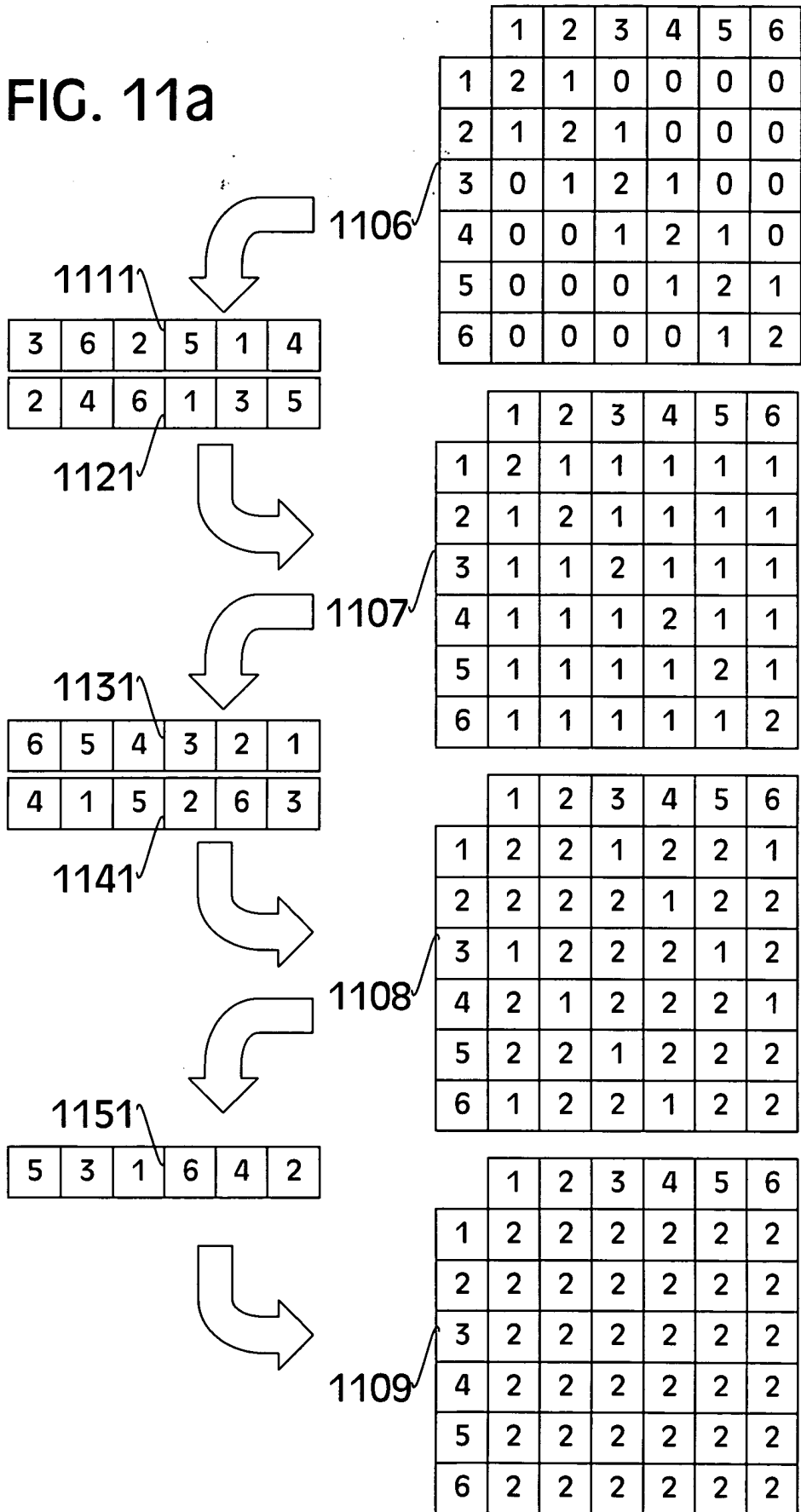

FIG. 11b

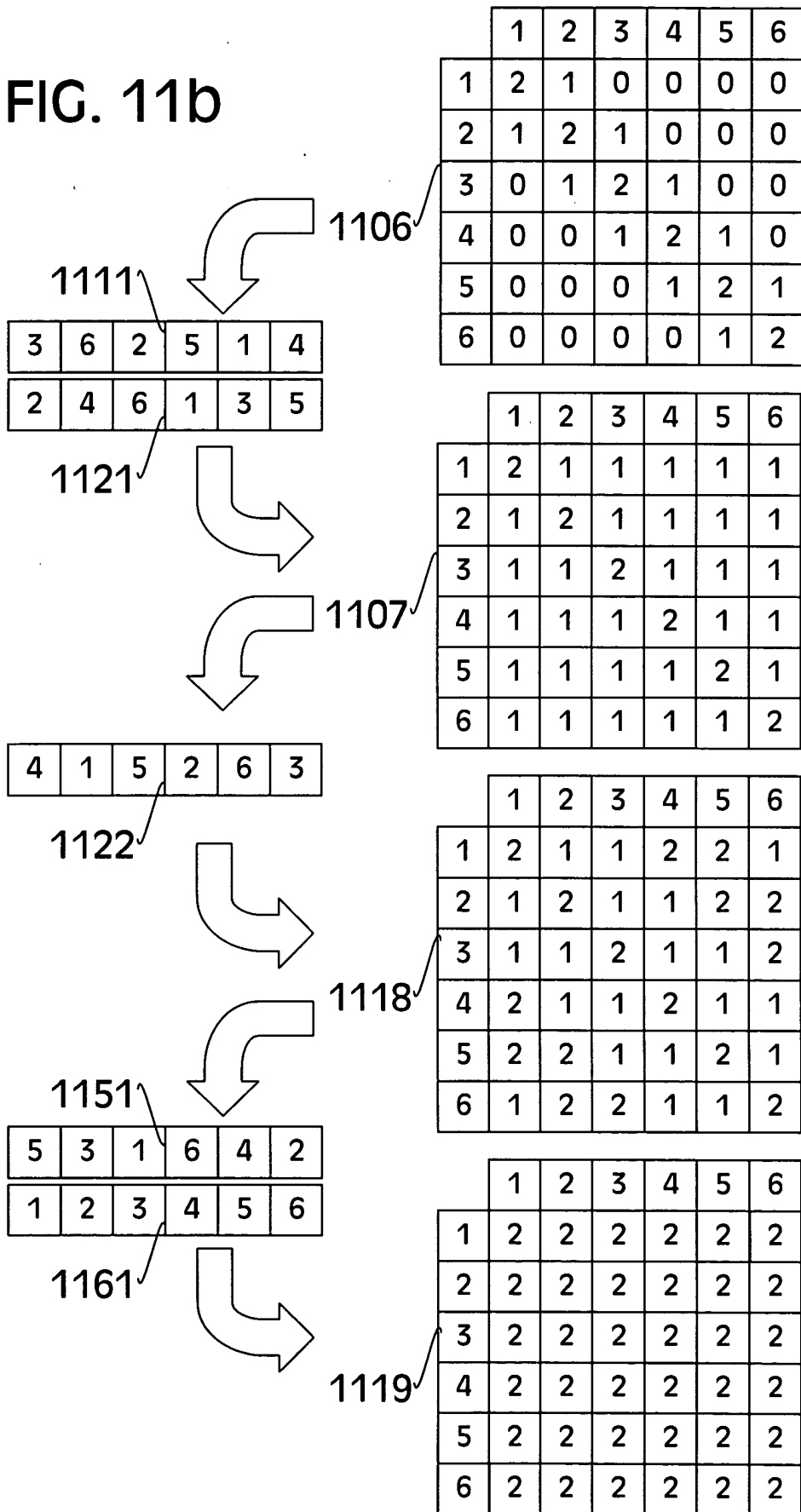

FIG. 11c

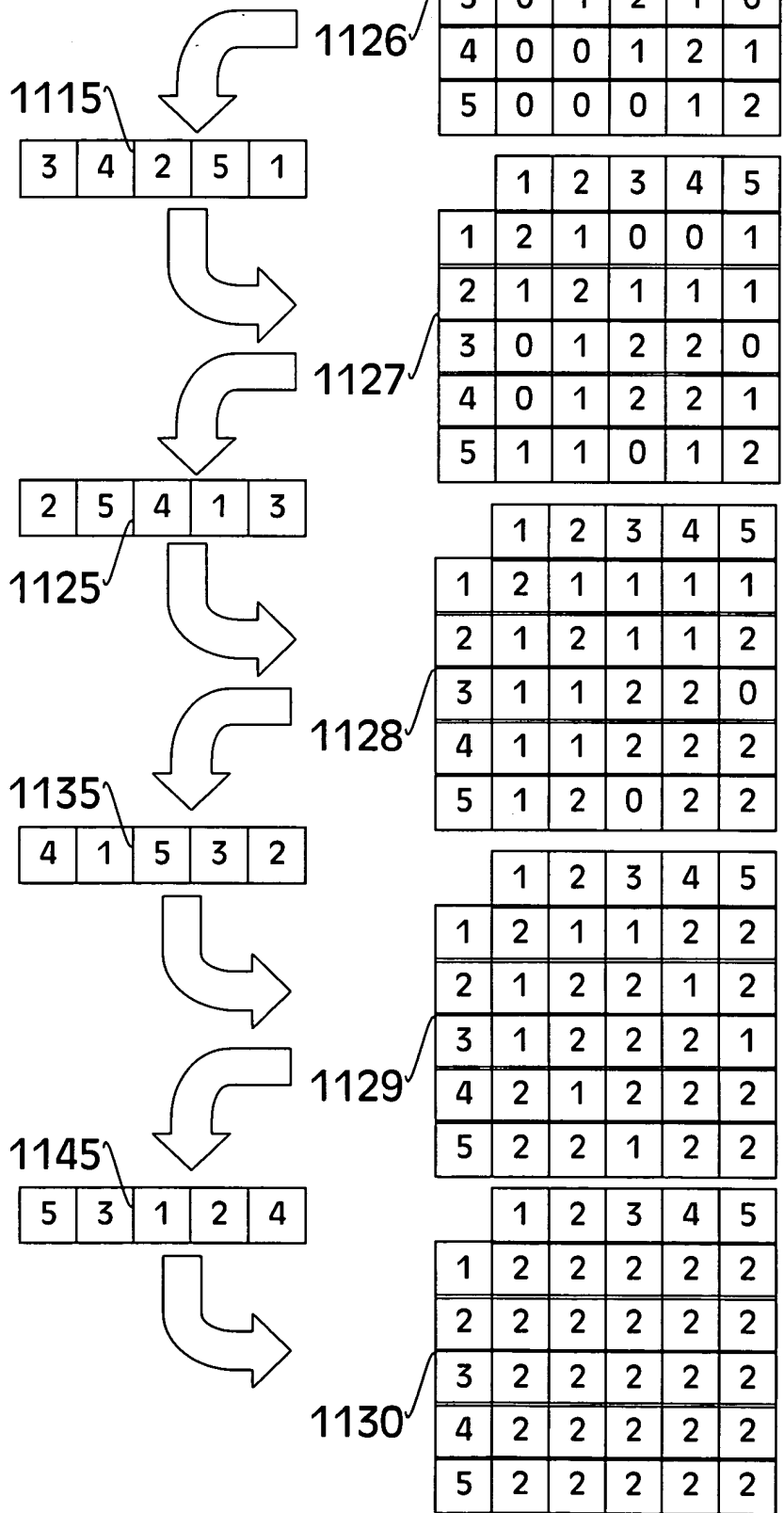

FIG. 12a

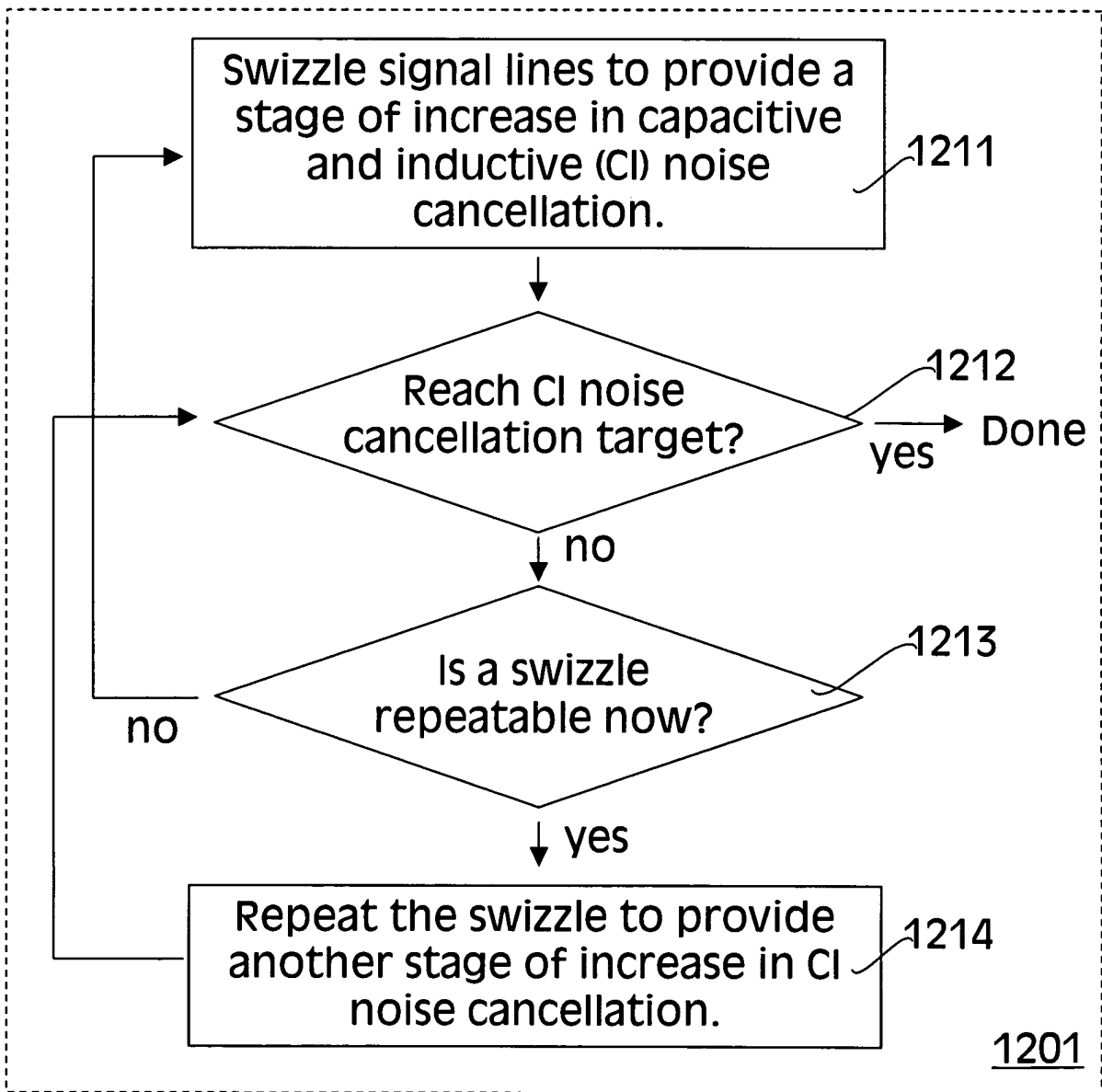

FIG. 12a



FIG. 12b

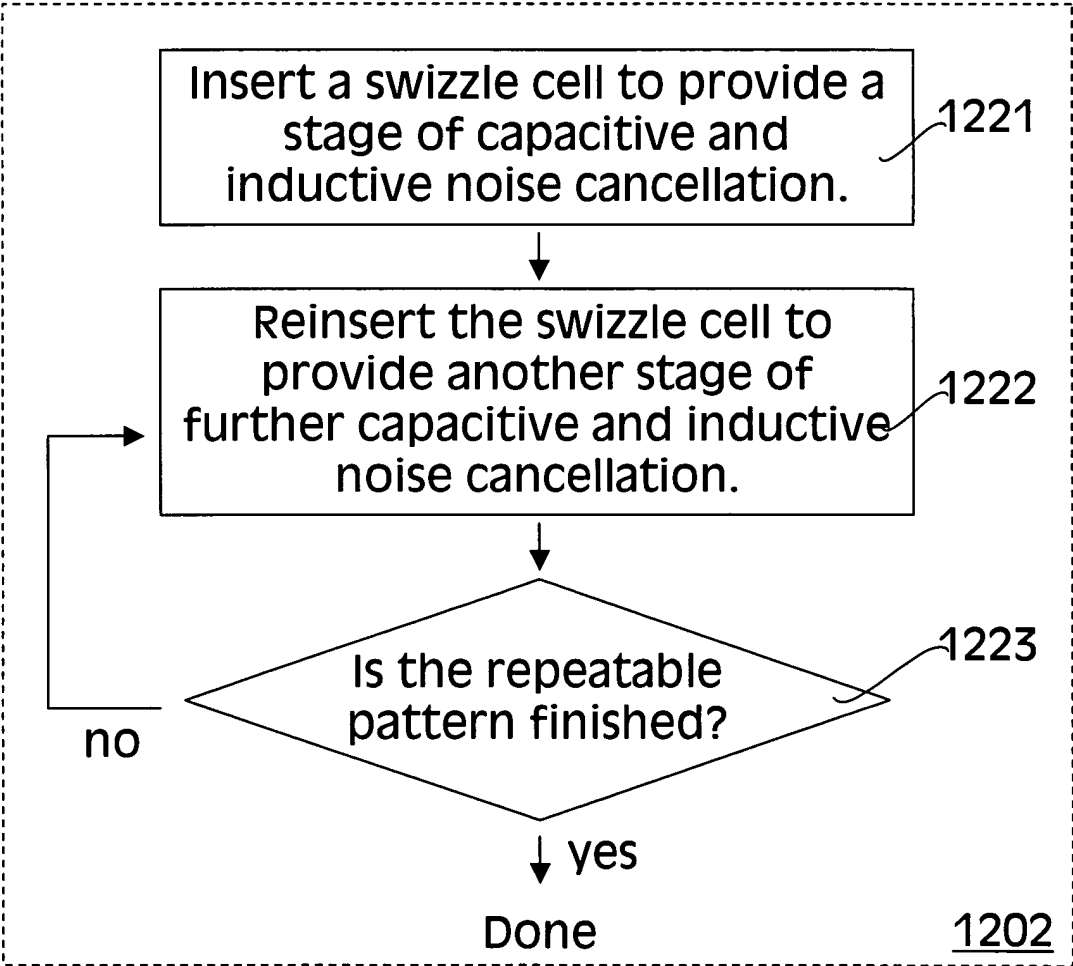

FIG. 12b

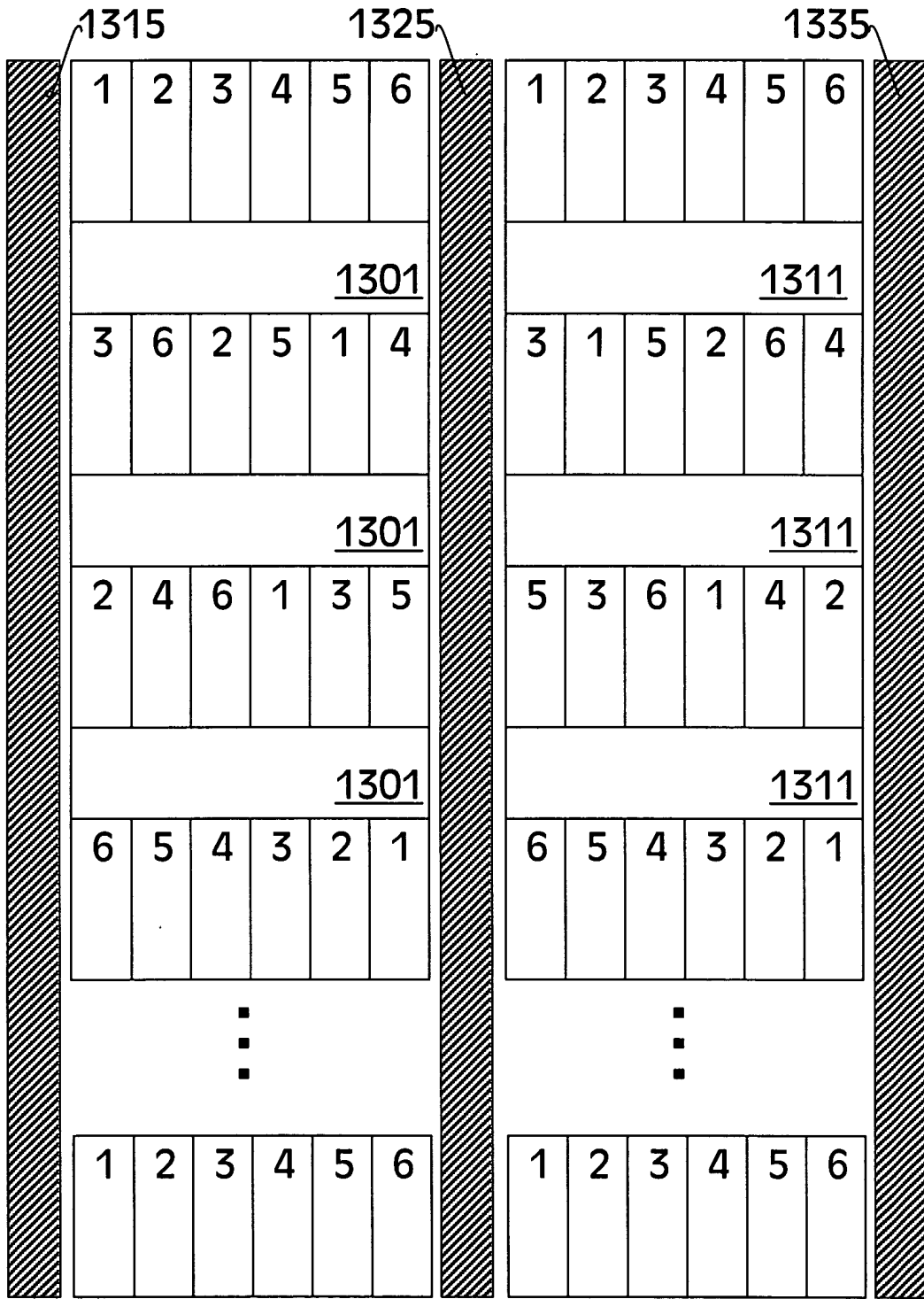

FIG. 13a

FIG. 13a "SEE FIG. 13a"

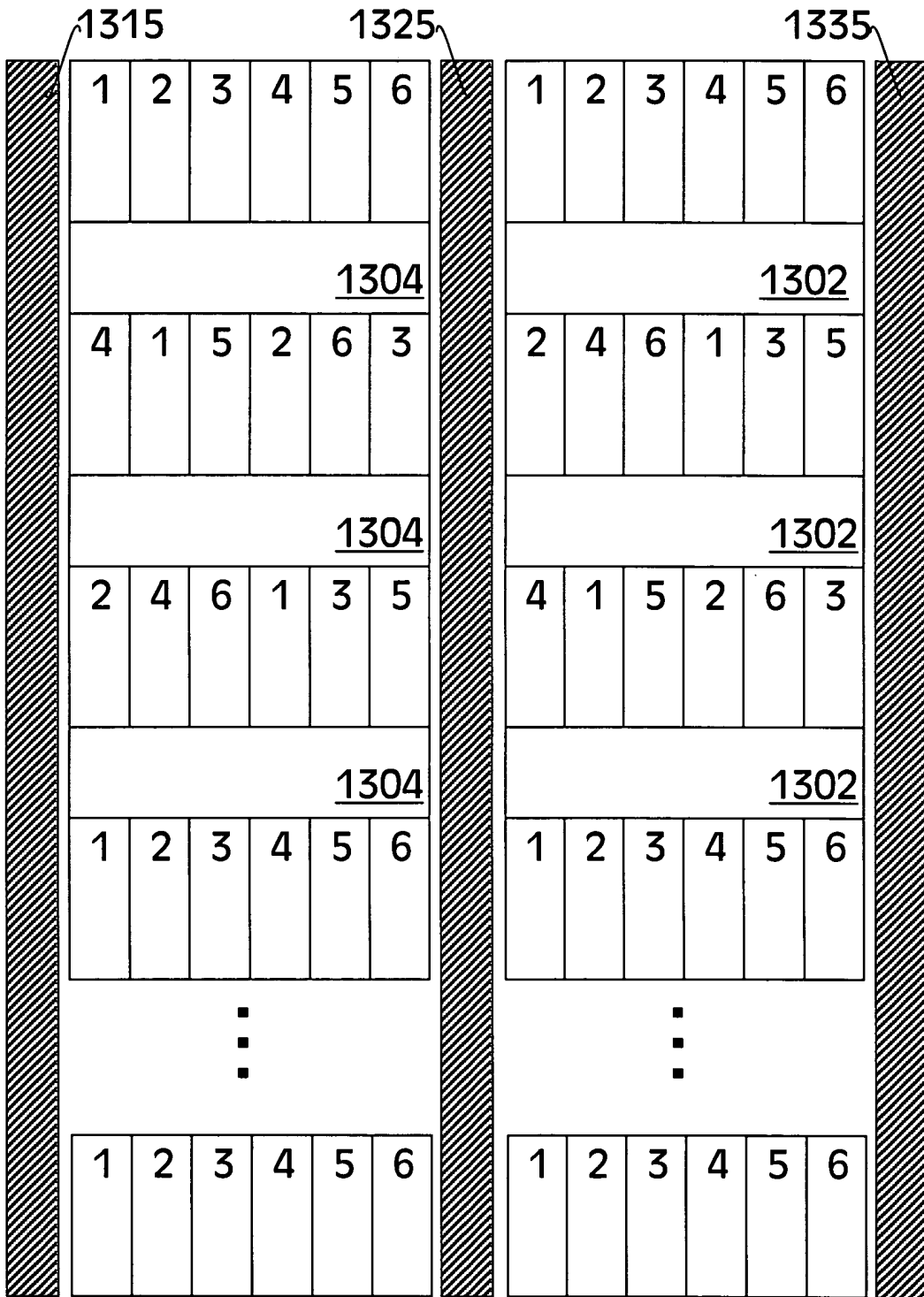

FIG. 13b

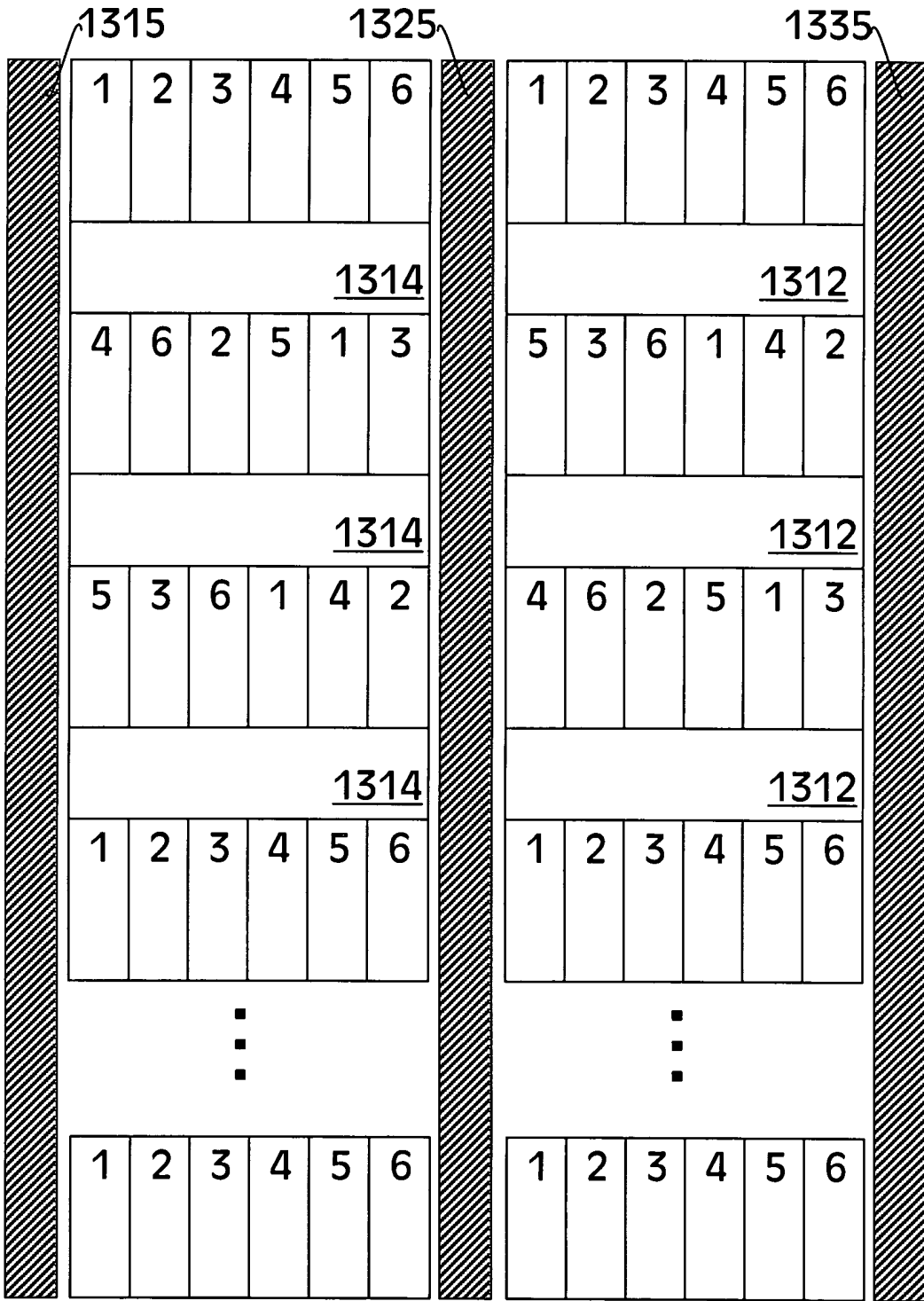

FIG. 13C

FORGET SECTIONS

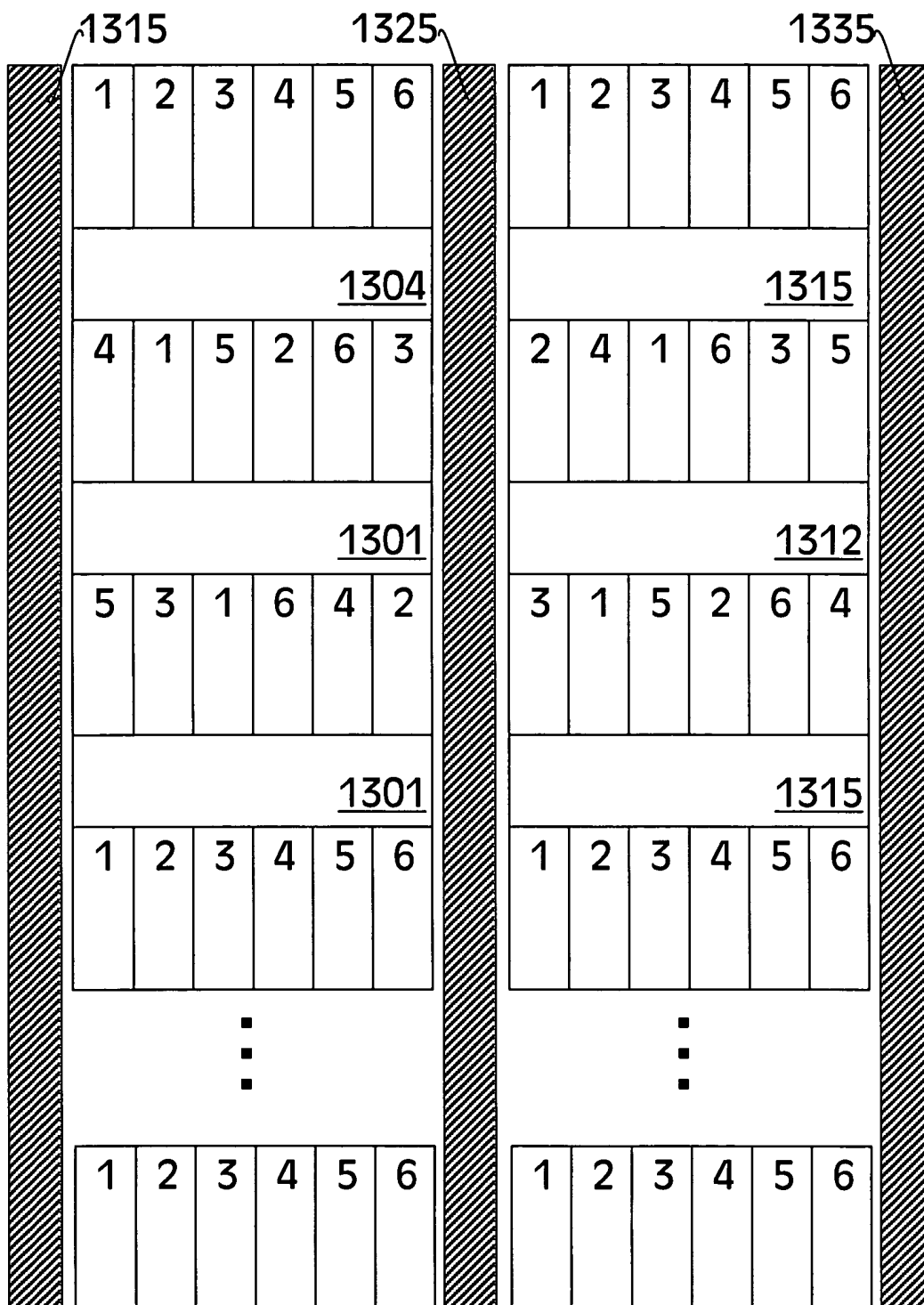

FIG. 13d

FIG. 14

